

P1038
Fitting 90° angle 90x51 3D14

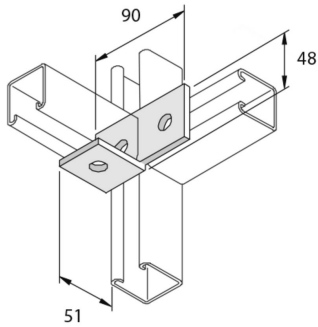

Reference	Finish	↕ mm	↔ mm	→ ← mm	↔ mm	kg/stk	📦	Unit
P1038	HG	51	48		90	0,317	10	STK

Abbreviation:
- HG = Hot-Dip Galvanised

Legend finish
- HG = Hot-dip galvanised