

**P1546SS**  
Fitting angle 45° 2D14

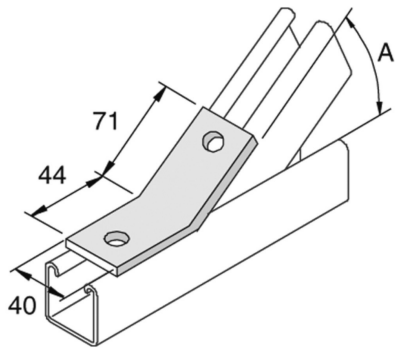

Reference	↕ mm	↔ mm	→  ← mm	↔ mm	kg/stk	📦	Unit
<b>P1546SS</b>		40			0,194	10	STK