

P2095SS
Fitting angle 75° 2D14

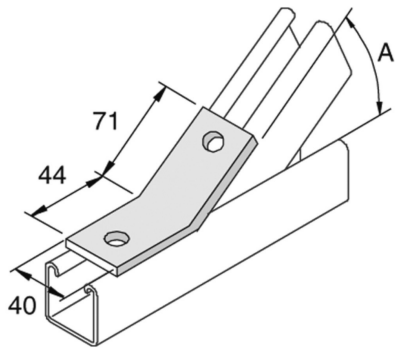

Reference	↕ mm	↔ mm	→ ← mm	↔ mm	kg/stk	📦	Unit
P2095SS		40			0,194	10	STK