

P2097SS
Fitting angle 60° 2D14

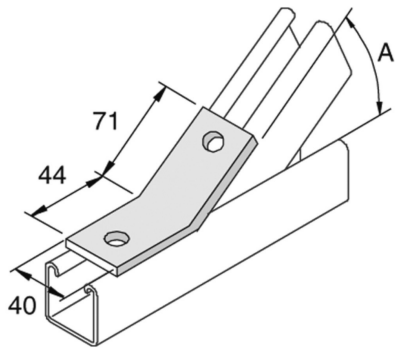

Reference	↕ mm	↔ mm	→ ← mm	↔ mm	kg/stk	📦	Unit
P2097SS		40			0,194	10	STK