

P1272SS

Etrier de Fixation C25

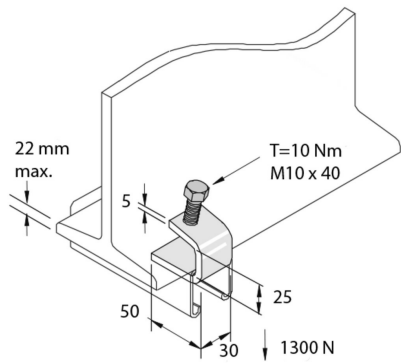

| Référence | ↕ mm | ↔ mm | → ← mm | ↔ mm | kg/stk | 📦 | Unité |
|----------------|---------|---------|------------|---------|--------|----|-------|
| P1272SS | 25 | 30 | | 50 | 0,123 | 20 | STK |