

# P1326SS

## Equerre 90° L 2D14

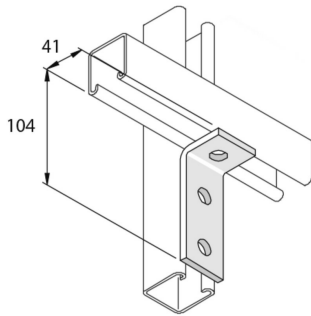

Référence	↕ mm	↔ mm	→  ← mm	↔ mm	kg/stk	📦	Unité
<b>P1326SS</b>	41	40		104	0,219	20	STK