

# P1038

## Verbindingsstuk hoek 90° 90x51 3D14

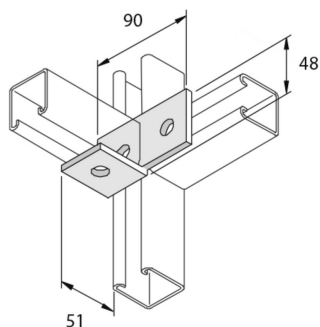

Artikel	Afwerking	↕ mm	↔ mm	→  ← mm	↔ mm	kg/stk	📦	Eenh.
<b>P1038</b>	HG	51	48		90	0,317	10	STK

Afkorting:

- HG = Hot-Dip Gegalvaniseerd

**Legende afwerking**

- HG = Thermisch verzinkt