

P2103

Verbindingsstuk geplooid 15° 2D14

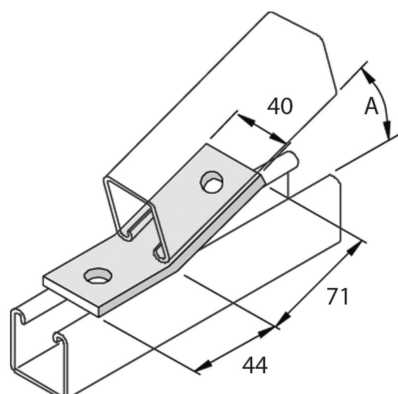

Artikel	Afwerking	↕ mm	↔ mm	→ ← mm	↔ mm	kg/stk	📦	Eenh.
P2103	HG					0,188	10	STK

A = 15°

Afkorting:

- HG = Hot-Dip Gegalvaniseerd

Legende afwerking

- HG = Thermisch verzinkt